

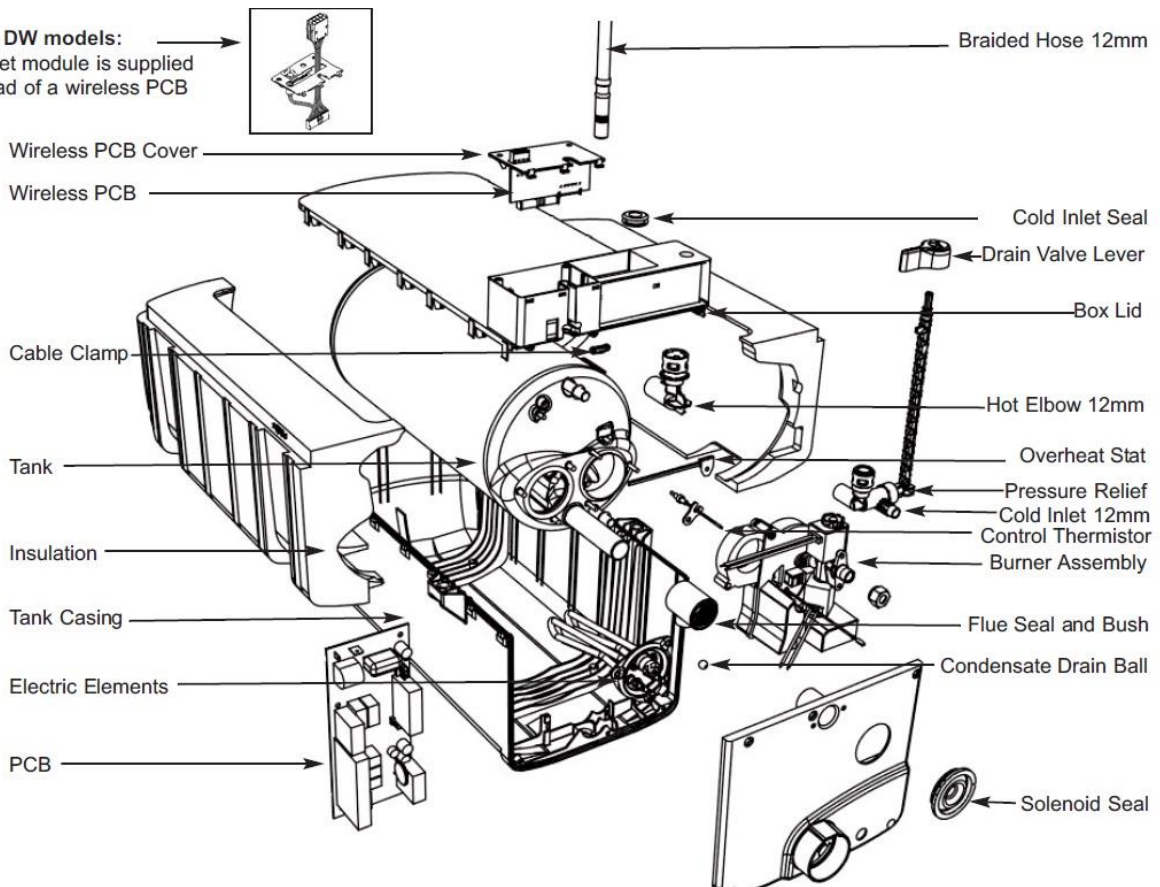





Expanse Gass & Elektrisk Vannvarmer





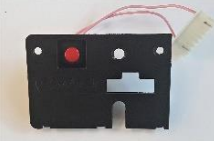









Note DW models:

A reset module is supplied instead of a wireless PCB



Artikkel nr	Description	Image
AK1275	Expanse, Gass + Elektrisk Dreneringsventil for sanitærvann	
AK1277	Expanse Kretskort Zigbee Spitfire 782.29 (for iVan Space Heater system) Opp til 2020/ IW	
Z-782.96 Rosa ledninger	Expanse Re-set knapp (inkl i AK1277) (for iVan Space Heater system) etter 2016 w/ 782.115	
Z-782.96 Gule ledninger	Expanse Re-set bryter (inkl i AK1277) (for iVan Space Heater system) Før 2016 w/ 782.20	
Z-782.112	Expanse Re-set for Duo Control, Pre LIN	
AK1293	Expanse Kommunikasjonskort 886.01 2020 Kun iVan modeller	
AK1294	Expanse Kommunikasjonskort 886.02 2020 Kun Duo Control modeller	
AK1278	Expanse Brenner Assy 1.35kW	
AK1280	Expanse Elektrisk element Assy 1.5kW	
AK1281	Expanse Gass + Elektrisk Temperatursensor	

AK1282	Expanse Gass Overopphetingsbryter	
AK1276	Expanse Hovedkretskort Gass og Elektrisk 782.20 WW GE IW/DW til 06/16 w/ gml AFS	
AK1900	Expanse Hovedkretskort Gass Elektrisk 782.115 DW/ IW fra 07/16	
AK1901	Expanse Hovedkretskort Gass 782.96 WW G	
AK1902	Expanse Hendel for dreneringsventil	
AK1903	Expanse 230 V Kabel 3 leder JST Z-782.28	
AK1904	Expanse Betjeningspanel for anlegg Gass og Elektrisk Z-782.47	
AK1905	Expanse Betjeningspanel for anlegg Gass Z-782.49	
AK1906	Expanse Ledningsnett for anlegg Gass og Elektrisk 3.5m Z-782.48	
AK1907	Expanse Ledningsnett for anlegg Gass 3.5m Z-782.100	
AK1908	Expanse Ledningsnett for anlegg gass 7.0m Z-782.114	
AK1909	Expanse Terminal for eksos og innsugsrør	

AK1801B	LIN-Kabel 7.0m	
AK1884	Expansje Slange 12mm x 12mm	
AK1910	Expansje Hovedkretskort Gass og Elektrisk 782.127 WL GE	
AK1911	Expansje Hovedkretskort Gass 782.129 WL G	
AK1912	Expansje LIN-kretskort fra 01/2021 782.128 WL	
AK1228	Vakuumbestemt avlastningsventil	

Erstatningsvarmere

Hvis en erstatningsvarmer er nødvendig, vennligst se tabellen nedenfor for å finne ut hvilken reservevarmer som kreves for å erstatte den.

Varmer Kit	Varmer
WW0801Ox	AK1913
WW0801Ux	AK1914
WW0821Ox	AK1915
WW0821Ux	AK1916
DW0801	AK1917
DW8202	AK1918
DW8212	AK1919
IW0801Ox	AK1920
IW0801Ux	AK1921
IW8212	AK1922
WL8201	AK1923
WL8211	AK1924
WL8202	AK1925
WL8212	AK1926